

# Stückliste /Parts List 499 165 5205CBL

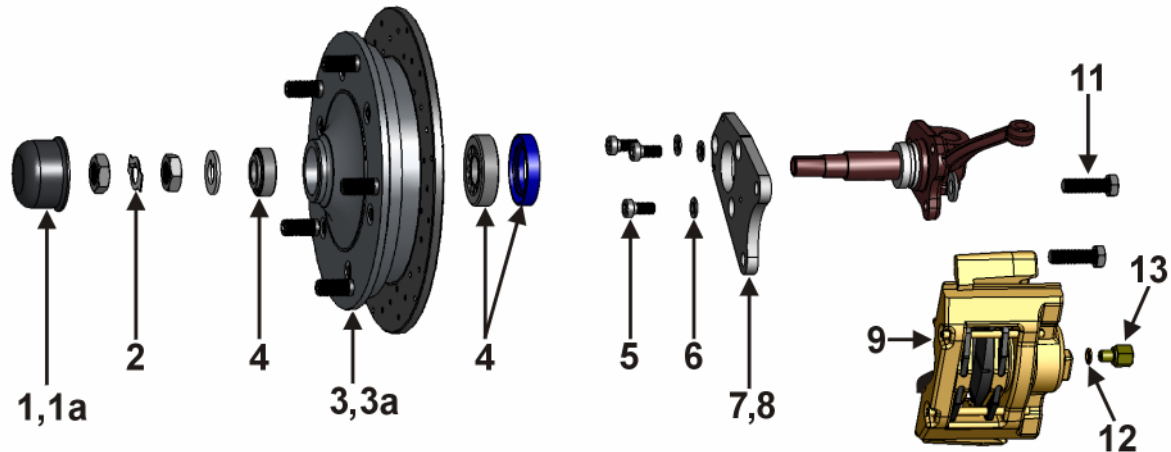

Verpack.art Location	Position Number	Bestell-Nr. Part-#	Bezeichnung Description	Anzahl Quantity	
<i>Blister skinpacked</i>	1	405 691 000	Nabendeckel links Grease Cap left	1	
<i>Blister skinpacked</i>	1a	405 692 000	Nabendeckel rechts Grease Cap right	1	
<i>Blister skinpacked</i>	2	405 681 111	Sicherungsblech Typ-1 -65 Lock Washer	2	
<i>Karton Box</i>	3	X405 579 165L	Radnabe kompl. Typ-1 -65 L, links Aluminium Hub Assembly Type-1 -65 L, left	1	
<i>Karton Box</i>	3a	X405 580 165L	Radnabe kompl. Typ-1 -65 L, rechts Aluminium Hub Assembly Type-1 -65 L, right	1	
<i>Karton Box</i>	4	498 201 111CSP	Radlagersatz mit Simmerring Wheel Bearings with Seal	2	
<i>Blister skinpacked</i>	5	009 6912 1020	Schraube DIN 6912, M10x20, 10.9 Bolt for Caliper Bracket, DIN 6912, M10x20, 10.9	6	
<i>Blister skinpacked</i>	6	009 0127 10	Federring DIN 127, M10 Safety washer M10	6	
<i>Blister skinpacked</i>	7	615 201 111CB	Bremssattelhalteplatte links Caliper Bracket Left	1	
<i>Blister skinpacked</i>	8	615 202 111CB	Bremssattelhalteplatte rechts Caliper Bracket Right	1	
<i>Karton Box</i>	9	698 461 000	Bremssättel mit Belägen Calipers with pads	1	
<i>Blister skinpacked</i>	11	009 0912 121540	Schraube DIN 912, M12x1,5x40 Caliper Bolt, DIN 912, M12x1.5x40	4	
<i>Blister skinpacked</i>	12	009 7603 1014	Kupferferring DIN 7603, 10x14x1 Copper Seal, DIN 7603, 10x14x1	2	
<i>Blister skinpacked</i>	13	611 701 000	Adapter Bremsschlauch Adapter for Brake Hose	2	
<i>Beipack loose part</i>	ohne Abb.	611 701 211	Bremsschlauch Brake Hose	2	
<i>Blister skinpacked</i>	ohne Abb.	000 604 SS	Schraubensicherungsmittel Loctite	1	
<i>Blister skinpacked</i>	ohne Abb.	012 120 615	Kunststoff-Dorn Plastic drive	1	

Stand: Nov-13

Datum / Date: \_\_\_\_\_

zusammengestellt von / pulled by : \_\_\_\_\_