

Stückliste / Parts List 499 327 5205L

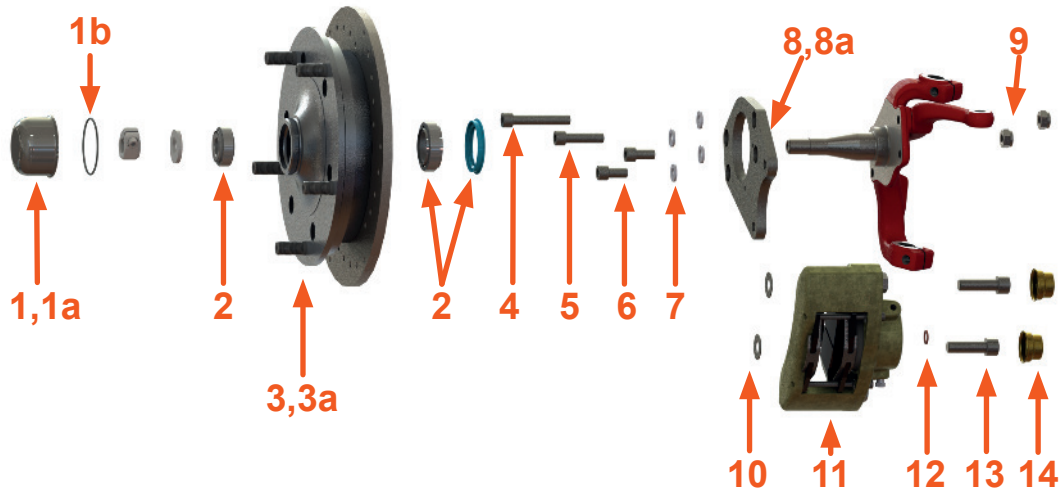

Artikel ohne Nummer sind nicht im Lieferumfang enthalten
Items without reference are not part of the kit

http://docs.csp-products.de/?partlist=499 327 5205L

Verpack.art Location	Position Number	Bestell-Nr. Part-No.	Bezeichnung Description	Anzahl Quantity
Blister skinpacked	1	405 691 000	Nabendeckel links Grease Cap left	1
Blister skinpacked	1a	405 692 000	Nabendeckel rechts Grease Cap right	1
Karton Box	1b	009 9000 5420	O-Ring, 54x2 O-ring, 54x2	2
Blister skinpacked	2	498 201 311	Radlagersatz mit Simmerring Wheel Bearings with Seal	2
Karton Box	3	X405 579 167L	Radnabe kompl. Typ-1 66-67, links Aluminium Hub Assembly Type-1 66-67, left	1
Karton Box	3a	X405 580 167L	Radnabe kompl. Typ-1 66-67, rechts Aluminium Hub Assembly Type-1 66-67, right	1
Blister skinpacked	4	009 0912 101060	Schraube DIN 912, M10x1x60, 10.9 Bolt for Caliper Bracket, DIN 385, M10x1x60, 10.9	2
Blister skinpacked	5	009 0912 101040	Schraube DIN 912, M10x1x40, 10.9 Bolt for Caliper Bracket, DIN 385, M10x1x40, 10.9	2
Blister skinpacked	6	009 0912 101020	Schraube DIN 912, M10x1x20, 10.9 Bolt for Caliper Bracket, DIN 385, M10x1x20, 10.9	4
Blister skinpacked	7	009 0127 10	Federring DIN 127, M10 Safety Washer M10	8
Blister skinpacked	8	615 201 311	Bremssattelhalteplatte links Caliper Bracket left	1
Blister skinpacked	8a	615 202 311	Bremssattelhalteplatte rechts Caliper Bracket right	1
Blister skinpacked	9	009 0985 101	Mutter DIN 985, M10x1 Safety Nut M10x1	4
Blister skinpacked	10	615 200 001	Distanzscheibe Bremssattel 1mm Spacer 1mm	4
Karton Box	11	698 461 000	Bremssättel mit Belägen Calipers with Pads	1
Blister skinpacked	12	009 7603 1018	Kupferring DIN 7603, 10x18x1 Copper Seal, DIN 7603, 10x18x1	2
Blister skinpacked	13	009 0912 121540	Schraube DIN 912, M12x1,5x40 Caliper Bolt, DIN 912, M12x1.5x40	4
Karton Box	14	611 485 000	Abdeckkappe Dust Cover	4
Beipack loose parts	ohne Abb. w/o Ref.	611 701 113D	Bremsschlauch Brake Hose	2
Blister skinpacked	ohne Abb. w/o Ref.	000 604 SS	Schraubensicherungsmittel Loctite	1
Blister skinpacked	ohne Abb. w/o Ref.	012 120 615	Kunststoff-Dorn Plastic Drive	1

Stand: Sept.-21

Datum / Date: _____

zusammengestellt von / pulled by : _____

