

Stückliste / Parts List 499 254 5205VL

Artikel ohne Nummer sind nicht im Lieferumfang enthalten
Items without reference are not part of the kit

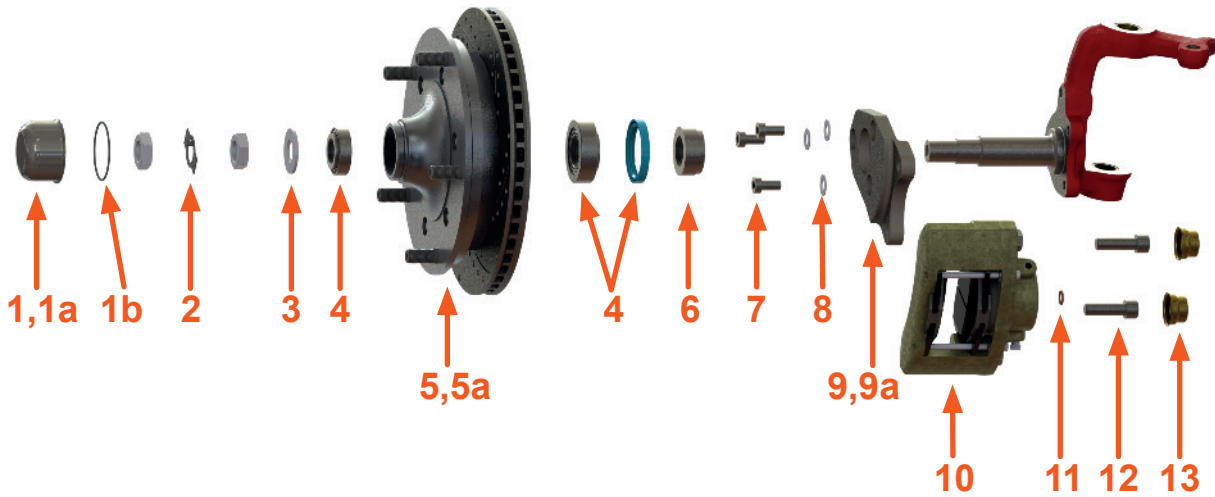

Verpack.art Location	Position Number	Bestell-Nr. Part-No.	Bezeichnung Description	Anzahl Quantity
Blister skinpacked	1	405 691 000	Nabendeckel links Grease Cap left	1
Blister skinpacked	1a	405 692 000	Nabendeckel rechts Grease Cap right	1
Karton Box	1b	009 9000 5420	O-Ring, 54x2 O-ring, 54x2	2
Blister skinpacked	2	405 681 211	Sicherungsblech Typ-2 -63 Lock Washer Type-2 -63	2
Blister skinpacked	3	405 661 263	Druckscheibe Radlager Typ-2 -63 Thrust Washer, Type-2 -63	2
Karton Box	4	498 200 211CSP	Radlagersatz mit Simmerring Wheel Bearings with Seal	2
Karton Box	5	X405 579 263VL	Radnabe kompl. Typ-2 50-63 V L, links Aluminium Hub Assembly Type-2 50-63 V L, left	1
Karton Box	5a	X405 580 263VL	Radnabe kompl. Typ-2 50-63 V L, rechts Aluminium Hub Assembly Type-2 50-63 V L, right	1
Blister skinpacked	6	405 631 254	Distanzring, Typ-2 50-54 CSP Bearing Spacer, Type-2 50-54 CSP	2
Blister skinpacked	7	009 6912 1020	Schraube DIN 6912, M10x20, 10.9 Bolt for Caliper Bracket, DIN 6912, M10x20, 10.9	6
Blister skinpacked	8	009 0137B 10	Scheibe DIN 137B, M10 Washer DIN 137B, M10	6
Blister skinpacked	9	615 201 356B	Bremssattelhalteplatte links Caliper Bracket left	1
Blister skinpacked	9a	615 202 356B	Bremssattelhalteplatte rechts Caliper Bracket right	1
Karton Box	10	698 461 000B	Bremssättel mit Belägen Calipers with Pads	1
Blister skinpacked	11	009 7603 1018	Kupferring DIN 7603, 10x18x1 Copper Seal, DIN 7603, 10x18x1	2
Blister skinpacked	12	009 0912 12540	Schraube DIN 912, M12x1,5x40 Caliper Bolt, DIN 912, M12x1.5x40	4
Karton Box	13	611 485 000	Abdeckkappe Dust Cover	4
Beipack loose parts	ohne Abb. w/o Ref.	611 701 113D	Bremsschlauch Brake Hose	2
Blister skinpacked	ohne Abb. w/o Ref.	000 604 SS	Bremsschlauch Brake Hose	1
Blister skinpacked	ohne Abb. w/o Ref.	012 120 615	Kunststoff-Dorn Plastic Drive	1

http://docs.csp-products.de/?partlist=499 254 5205VL

Stand: Sept.-21

Datum / Date: _____

zusammengestellt von / pulled by : _____

